

Libre Texting NSF SBIR A Proposal

Mohsen BANAN

<http://mohsen.banan.1.byname.net/ContactMe>

Neda Communications, Inc.

<http://www.neda.com>

April 2009

<http://www.neda.com/PLPC/100109>

Varbatim Copying Permitted

Libre Texting
Device SW

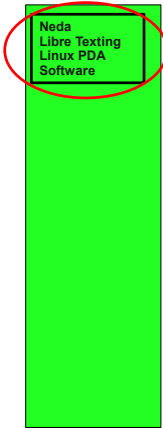

Libre Texting
Device HW

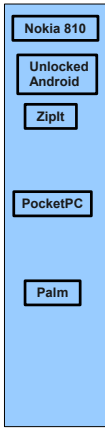

Wi-Fi++
Routers

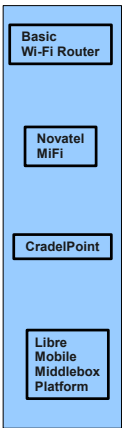

Networks

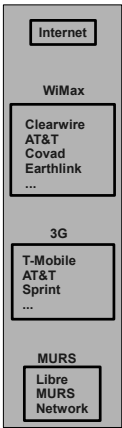

Message
Transfer
Agents

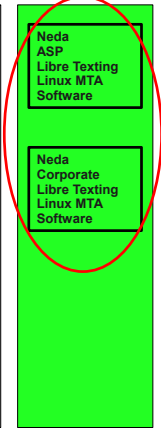

Libre Texting Parts

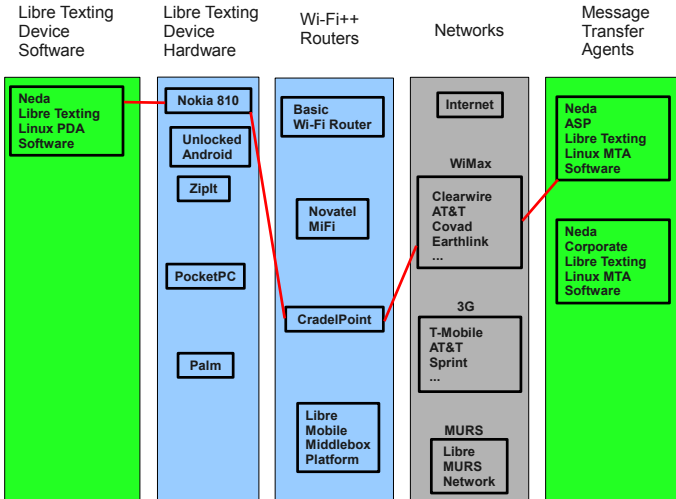

Libre Texting
Device SW

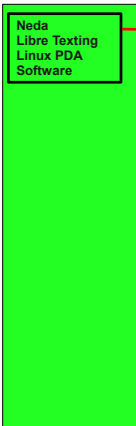

Libre Texting
Device HW

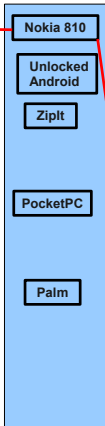

Wi-Fi++
Routers

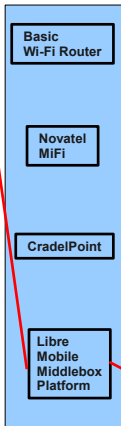

Networks

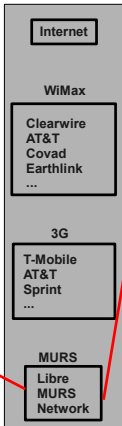

Message
Transfer
Agents

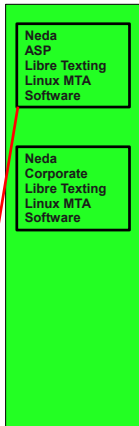

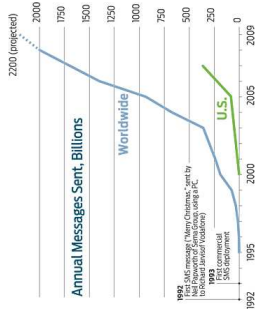

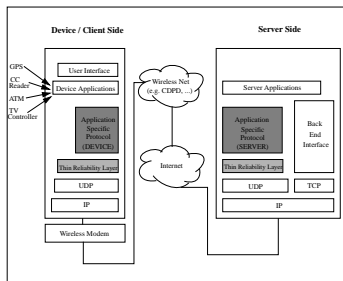

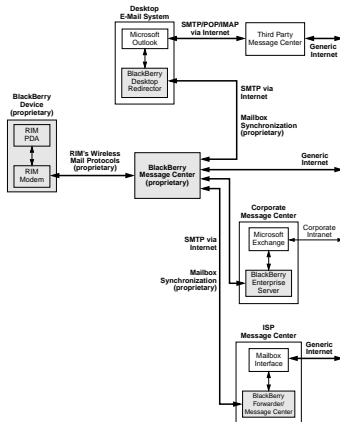

| | BlackBerry | WhiteBerry |
|----------------------------|--|---|
| Mobile Device | Only the two RIM-manufactured devices | Any suitable mobile device |
| Wireless Modem | Only the integral RIM modem | Any suitable wireless modem |
| Wireless Network | Only the BellSouth Intelligent Wireless Network | Any suitable wireless network |
| Message Center Service | Only the RIM-operated or RIM-licensed service | Any independent service provider; any corporate e-mail system |
| Protocols | Proprietary RIM protocols | Open LEAP protocols |
| Desktop Integration | Only Microsoft Outlook | Any desktop mail application |
| Message Center Integration | Only Microsoft Exchange | Any Message Center system |
| System Integration | Exclusively by RIM | Any systems integrator |
| Security | Not true end-to-end Implementation details unknown Precludes other implementations | Open paradigm permits external security implementation |

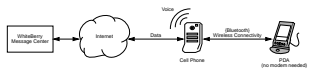

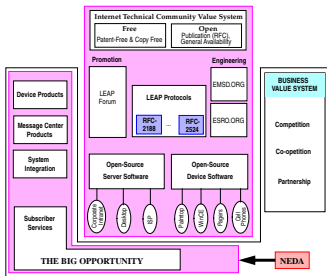

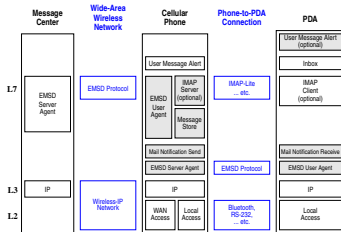

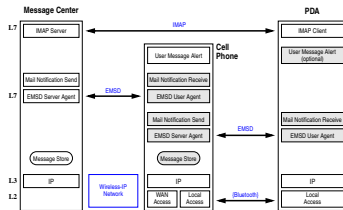

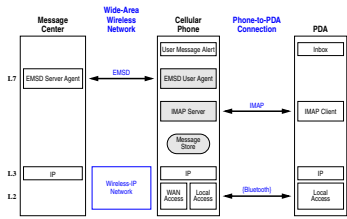

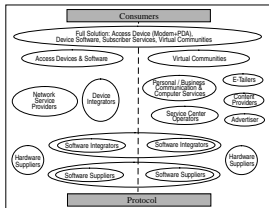

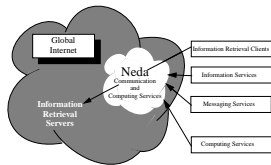

Secure and
Mobile
Applications

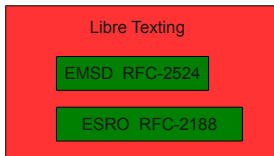

Secure and
Mobile
Overlay Network

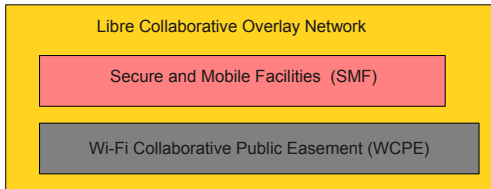

Wi-Fi
UnderNets

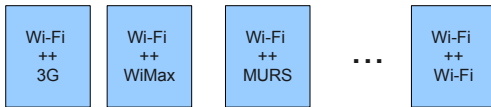

Libre Texting and Libre Collaborative Overlay Network and Wi-Fi++

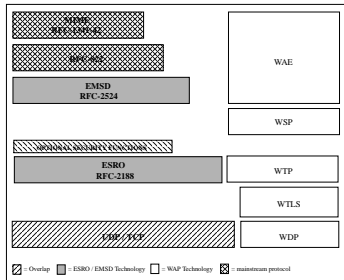

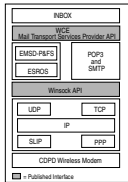

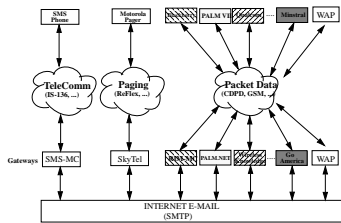

| | PUBLIC (ISP) | PRIVATE (Corporate Intranet) | PERSONAL (Desktop) |
|----------------------------------|---|--|--|
| Customer | Wireless Data Providers, Paging Operators, ISPs, ... | Intranet Messaging Operators Fortune 5000 | Desktop Users |
| Product Description | Message Center for ISPs, ... | Message Center for Intranet | Personal Desktop Forwarders |
| Platforms | Solaris, Windows NT | Windows NT, Solaris, most other UNIX platforms | Windows NT/95/98, Solaris, most other UNIX platforms |
| Typical End-Customers | AT&T, GTE, PSI, UUNET, Netcom, ... | Boeing, Virginia Mason Hospital, ... | YOU |
| Key Attributes | Manageability, Scalability, Reliability | Ease-of-use, Plug-and-play, Corporate Control | Ease-of-use, Plug-and-play, Personal Control |
| Analogy | Phone company provided voice mail (Octel, ...) | Corporate provided voice mail (Active Voice, ...) | Personal controlled voice mail (answering machine, ...) |
| Licensing | - 500-pack user license - \$8 to \$25 per user | - 50-pack user license - \$100 to \$300 per user | - Personal user license - \$25 per user |

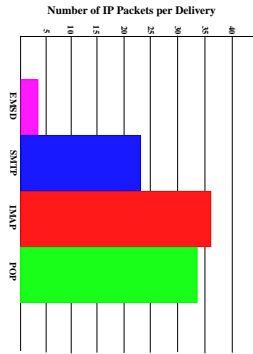

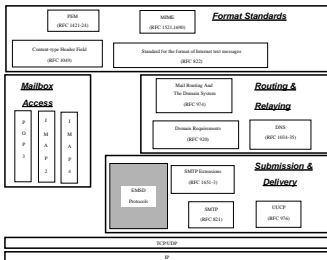

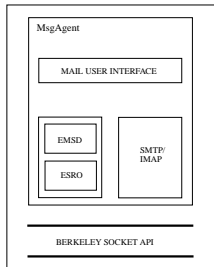

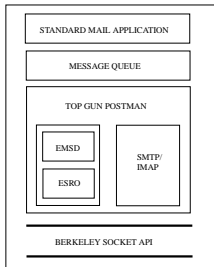

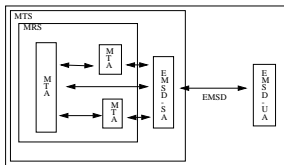

EMSD-SA Licensing Strategy

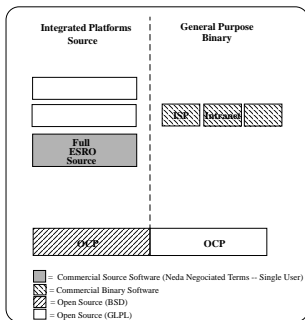

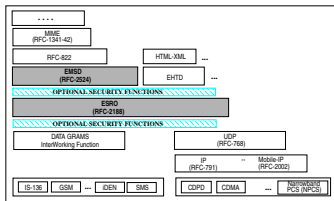

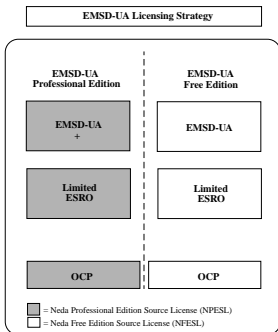

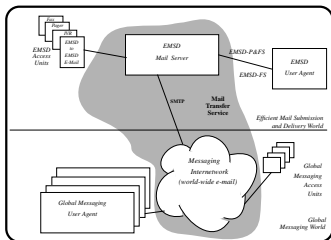

ESRO Licensing Strategy

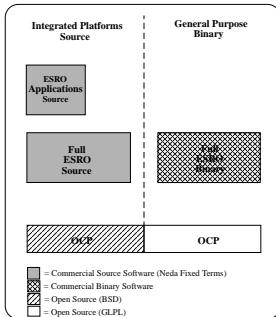

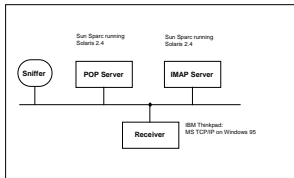

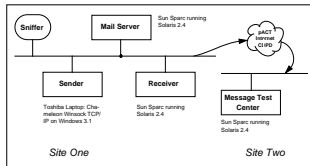

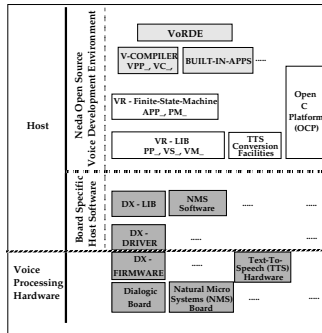

The Global Revenue for wireless access to the Internet and Intranet-Centered Services, Equipment, and Software: 1997 to 2002

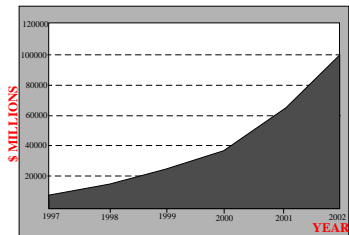

SOURCE: Killen & Associates, Inc.

| | OPEN DEVICES | | | CLOSED DEVICES | | |
|------------------------|--------------|------------------|------------|----------------|-----------------------|---------------|
| | Palm Pilot | WinCE | Other PDAs | Other Phones | Wireless Modems | Wireless PDAs |
| Customer/User | You | You | You | | | |
| Typical Devices | | | | | Sierra, Novatel | |
| Platform | | | | | Minstrel, AirCard 300 | Palm VII |
| Professional Licensing | Shrink Wrap | Neda Prof Source | | | | |
| Free Licensing | GPL | None | None | | | |

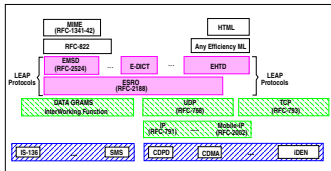

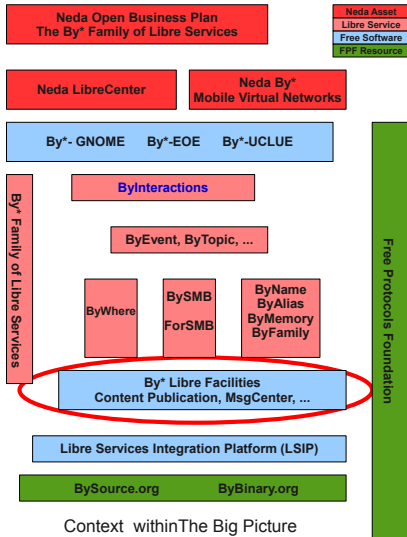

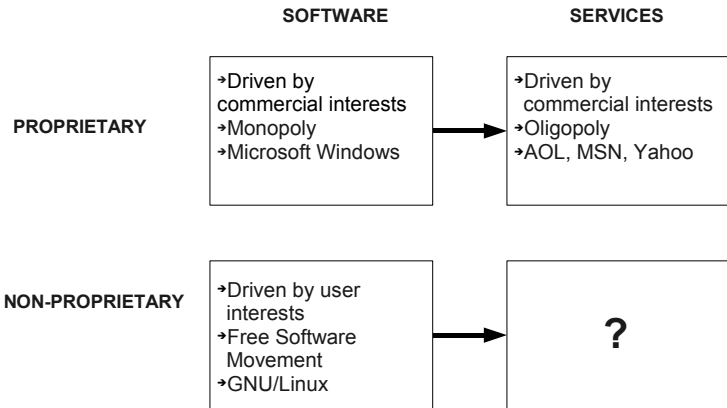

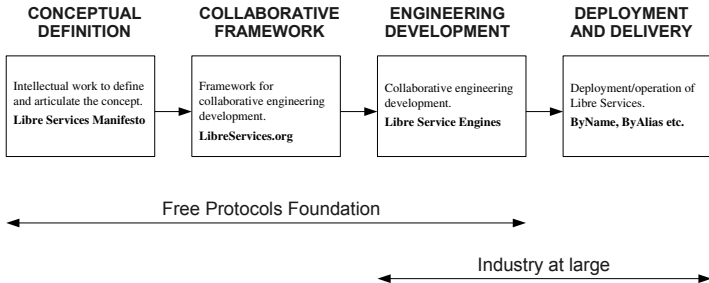

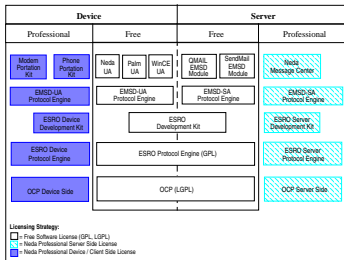

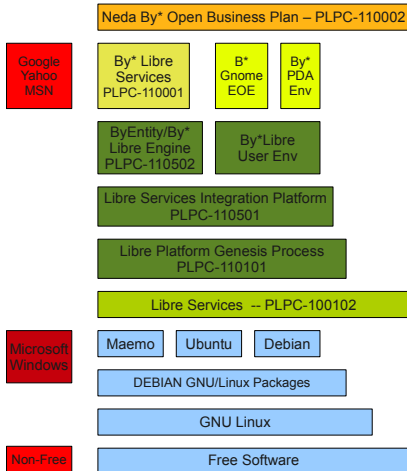

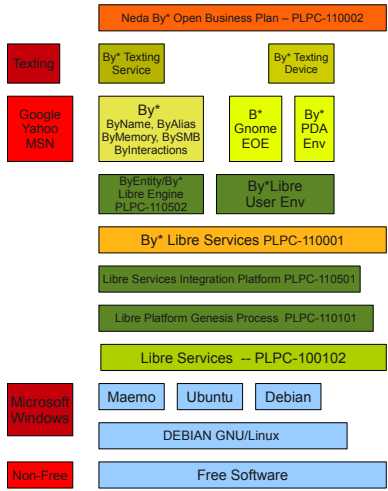

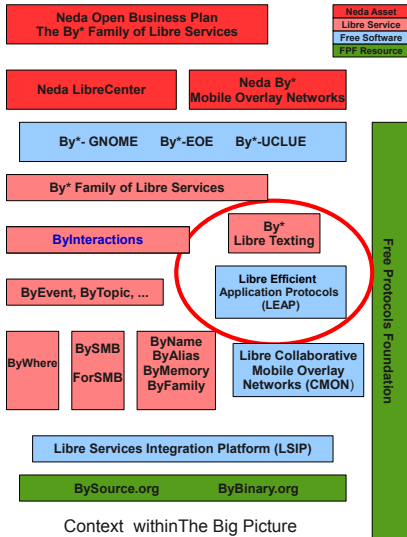

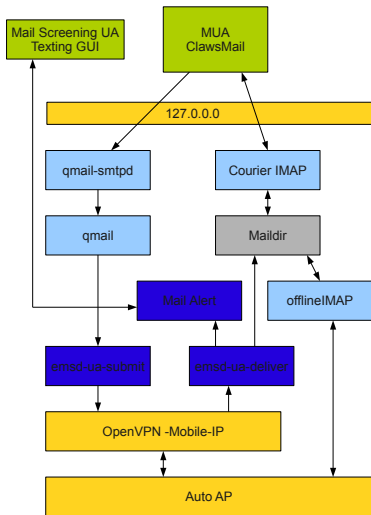

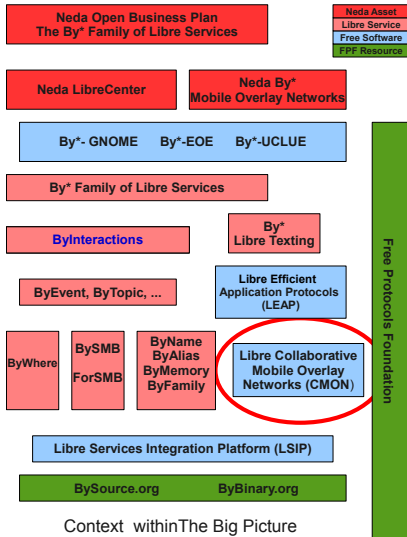

| |
|---------------|
| Neda Asset |
| Libre Service |
| Free Software |
| FPF Resource |

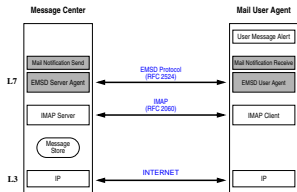

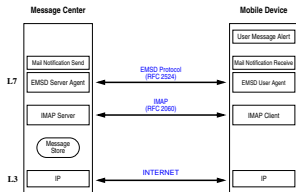

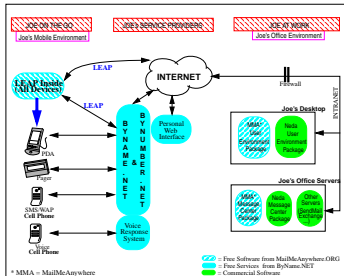

| Web Site | Information Type | Description |
|--|-------------------------------|---|
| www.EMSD.org www.ESRO.org www.LEAFForum.org | PROTOCOLS AND STANDARDS | <ul style="list-style-type: none"> - Base Protocol Specifications - White Papers - Application Programming Interfaces - Supported Subnetworks and Devices - Related Mailing Lists |
| www.FreeProtocols.org | PATENT FREEDOM | <ul style="list-style-type: none"> - Free Protocols Process & Procedures |
| www.NEDA.com www.MailMeAnywhere.org | PRODUCTS | <ul style="list-style-type: none"> - FREE Customer Products Windows CE Software for Enhanced Two-Way Paging - Message Center Products (Solaris) - Developer Toolkits - Service Bureau & Intranet Products |
| www.ByNumber.net www.ByName.net | SUBSCRIBER SERVICES | <ul style="list-style-type: none"> - FREE Mobile Messaging Accounts - Web Based Message Origination - Interactive Voice Response Service for Enhanced Two-Way Paging - Advanced services for the sophisticated mobile professional - A coherent package addressing all of your personal communication needs in one place using "Your Name" |

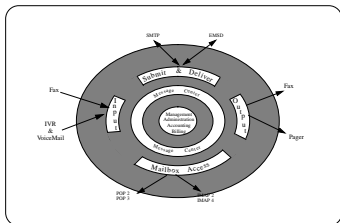

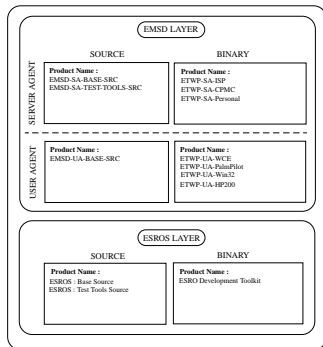

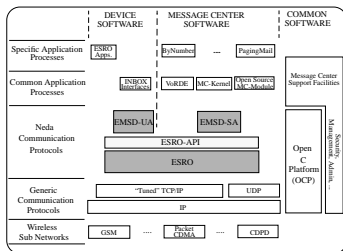

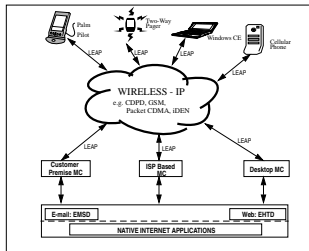

From: Mohsen Banan <mohsen.neda.com>
To: Mohsen Banan-Pager <873456@pager.neda.com>
Mime-Version: 1.0
Content-Type: text/plain; charset="us-ascii"
You will get this plain text email as alphanumeric page

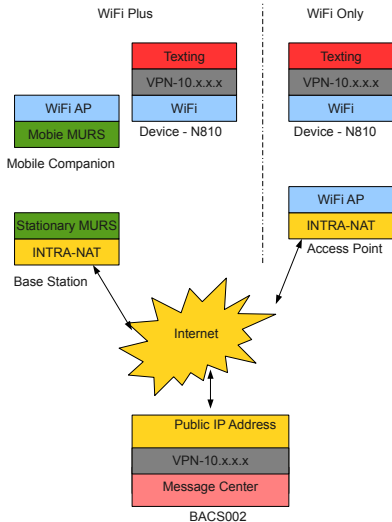

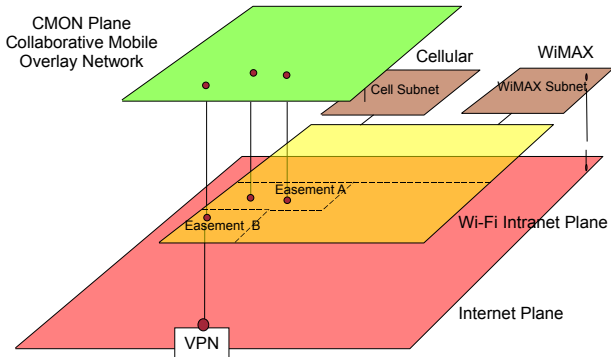

| Use | Protocol | Usage/ Publications | Publication Availability | Open Source Implementation | Commercial Implementation | Development/ Maintenance | Standards Body Blessing | Long-term Success |
|--------------|--------------------|------------------------|-----------------------------|-------------------------------|------------------------------|-----------------------------|-------------------------------|----------------------|
| Architecture | TCP/IP | Free | RFC / Open | Many | Many | Open | IETF (IStar) | Success |
| | SNA/DECnet | Licensed | Closed | None | Few | Closed | None | Fail |
| | ISO/OSI | Free | ISO/Limited | Few | Many | Limited | ISO | Fail |
| E-Mail | SMTP | Free | RFC / Open | Many | Many | Open | IETF (IStar) | Success |
| | X.400 | Free | ITU/Limited | Few | Many | Limited | ITU | Fail |
| | MC-Mail CC-Mail | Licensed | Closed | None | Few | Closed | None | Fail |
| Security | S/MIME | Free | RFC / Open | Few | Few | Open | IETF | Fail |
| | PGP | Free | RFC / Open | Many | Few | Open | None | Success |
| WWW | HTTP/HTML | Free | RFC / Open | Many | Many | W3, Limited | None (W3 Later) | Success |
| → Wireless | LEAP | Free | RFC / Open | Many | Few | Open | None | ? |
| | WAP | Licensed/ Patented | Sell/Limited | Few | Few (Mon) | Limited (WAP Forum) | None | ? |

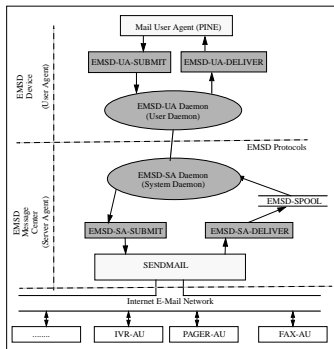

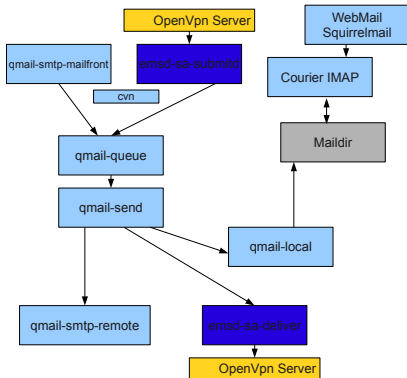

Form to be filled by a new subscriber

Full Name:

Postal Address:

City: State: Zip: Country:

Phone Number: Fax:
Area Code - local number Area Code - local number

International Phone Number:
Country Code - Area Code - local number

Pager:
Provider Number

Requested LSM Nickname:

Preferred "Reply To" Address:

Preferred "From" Name:

LSM Device IP Address:

To be filled by Neda

Neda Subscriber ID:

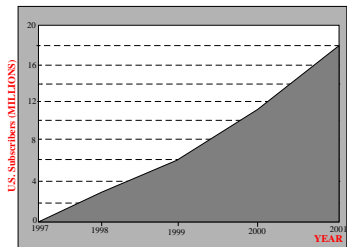

SOURCE: Donaldson, Lufkin & Jenrette Securities Corp.

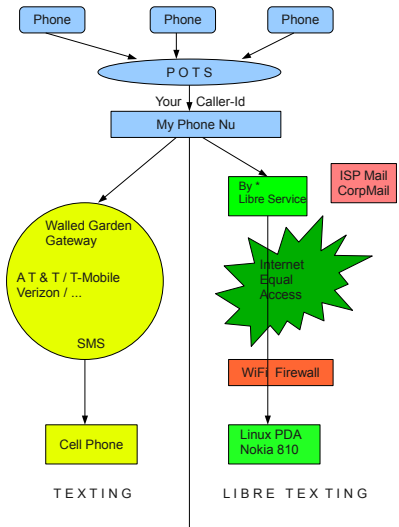

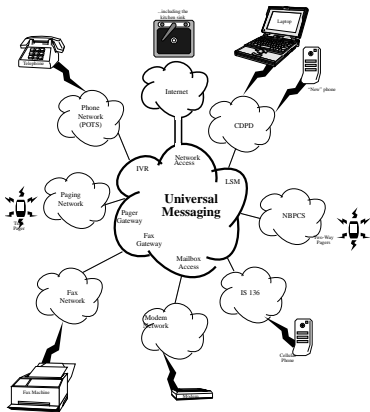

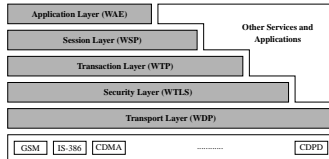

WAE - Wireless Application Environment
 WSP - Wireless Session Protocol
 WTP - Wireless Transaction Protocol
 WTLS - Wireless Transport Layer Security
 WDP - Wireless Datagram Protocol

(a) The Past:
WAP Architecture



(b) The Present:
XHTML



(c) The Future:
XHTML + LEAP



| WhiteBerry Step/Component | Lisa's Choice |
|---|--|
| 1. Select a PDA | Lisa chose to use a HP 660LX palmtop device, running Windows CE 2.0 |
| 2. Select a wireless network | Lisa selected the CDPD network |
| 3. Select a wireless modem | Lisa selected the Sierra Wireless Aircard 300, a CDPD modem which is compatible with her HP660LX |
| 4. Select a network Service Provider | Lisa chose AT&T since she resides in Seattle, and AT&T is the CDPD Service Provider for the Seattle area. |
| 5. Activate the modem | Lisa provided AT&T with the modem's EID (Equipment ID) number, received an IP address from AT&T, then configured the modem to use that address |
| 6. Download the LEAP device software | Lisa went to the MailMeAnywhere.org website, and downloaded the appropriate Windows CE LEAP software – in this case SH3 Gold Version 1.2 |
| 7. Select a Message Center operator | Lisa set up a free e-mail account for herself at ByName.net |
| 8. Select and install an e-mail forwarder | Lisa used FetchMail and Emacs Lisp code to define her directory and rule-based forwarding preferences |

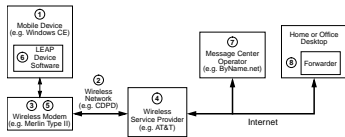

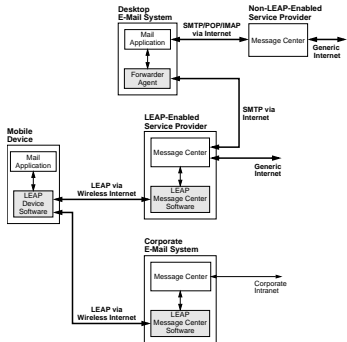

Wireless Mobile Data Market Forecast

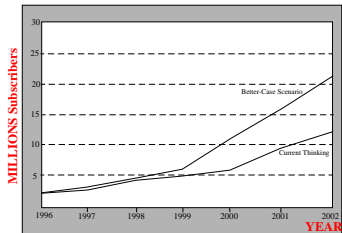

SOURCE: the Yankee Group, 1998

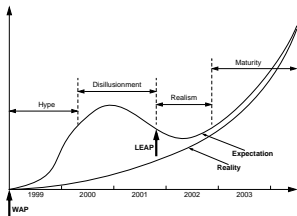

Causes for Concern

- Networks are societal resources and their usage model must not be left to free markets and business.
- The mobile Internet is today controlled by large corporations, and critical civil liberties are being compromised.
- Current Copyright and Patent laws are in conflict with nature and are harming humanity.
- As first generation engineers we have a responsibility to safeguard the societal welfare. The goal of this project is to:

Liberate Texting

Texting is Big Business

- Interpersonal communication on the go is the key value proposition for mobile networks

Texting: the Numbers

Sources: (Revenue) IFPI. RIAA; (Top five texters) Ovum, Quantifica

Texting: Future Trends
Sources: Acision; CTIA

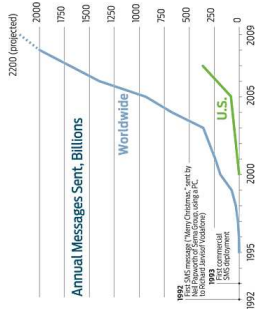

A Side-by-Side Real-World Comparison

- Existing: Mobile Phone Companies
- vs.
- New: Internet + Libre Software + Public Spectrum

Now Let's Compare

- Coverage
- Speed of delivery
- Ease of use / size / battery
- Cost
- Reliability
- Privacy / health / model
(to be discussed)
- Texting vs. Libre Texting
- Good Fair
- Good Excellent

- Good Good
- Low Lower
- Good Good
- (Poor) (Excellent)

Libre Texting:
the Run it Yourself Model

- Device: Get it yourself
 - Hardware platform: Linux PDAs; free market
 - Free/Libre software
- Service: Run it yourself
 - Libre Services
- Network: Own it yourself

- ● Public spectrum, free protocols, free software

Device: Get it Yourself

- Fully integrated; ready to run
- ● <http://store.neda.com>
- Hardware platform
- ● Linux PDAs; Nokia 810
- Ready-to-run software
- ● <http://www.bybinary.org>

Service: Run it Yourself

- For the individual
- ● <http://www.byname.net>
- ● <http://www.byalias.net>

- Corporate: software + CPE (customer-premises equipment)

- ● <http://www.bybinary.org>

- Corporate: software as service

- ● <http://www.ForSMB.net>

Network: Own it Yourself

- WiFi always used for final-leg device access

- WiFi++

- ● Final-leg WiFi + MURS (narrowband)

- ● Final-leg WiFi + WiMax etc. (broadband)

- ● Complete details in Libre Texting with {WiFi++}

<http://www.neda.com/PLPC/100027>

- Note to FCC:

More public spectrum please!

Public IP Address

Internet

WiFi++ Network Overview

Device: Linux PDA

E.g. Nokia 810

Access Point

Mobile Companion

WiFi Only

WiFi++

Base Station

Device: Linux PDA

E.g. Nokia 810

Implementing By* Libre Texting:

Scenario: WiFi-Only

- 1. Buy a Linux PDA, e.g. Nokia 810
- 2. Load it with mobile texting software
- ● <http://www.bybinary.org/>

- Or 1 & 2 combined: buy a preconfigured Nokia 810 texting device

- ● <http://store.neda.com/>

- 3. Get a ByName Libre Texting account

- ● <http://www.byname.net/>

Implementing By* Libre Texting:

Scenario: WiFi++

- First, steps 1, 2 and 3.
- Then:
- 4. Buy an MURS radio/modem
- 5. Activate the modem on Neda mobile network
-
- Try it!

- Simple and functional

The Many Dimensions of By* Libre Texting

- Libre Texting: a real-world alternative to texting
- Analysis of the texting medium
- Engineering execution: protocols, software, spectrum
- Libre Services model: philosophy, morality, legality
- By* Libre Texting Services
- Business Dimensions
- History
- Evaluation, participation, collaboration. Join us!

The Texting Medium: Now Well Established

- Content: Short text messages
- Expected near-immediate delivery
- Expected immediate alert
- Unconscious carry
- Mobile and always on

Texting: a Very Simple Application

- 1 Mobile and wireless network connectivity
- 1 Message submission (sending)
- 1 Message delivery (receiving)
- 1 Message processing (edit, save, reply, mailbox synchronize, etc.)

Texting: a Very Demanding Application

- ① Speed (delivery expectation: less than 10 seconds)
- ① Network capacity and efficiency (bandwidth)
- ① Device limitations (battery)
- ① Reliability (no lost messages)
- ① Scalability (eventually the whole planet's population)
- ① Coverage (eventually everywhere)

The Texting Medium Today:

Owned and Controlled

- Dominated by SMS and BlackBerry
- Based on the phone model
- Inside the phone companies' walled garden
- Not end-to-end: violates privacy

- Distinct from email
- Limited choice and non-transparent

The Wireless Service Provider Controls Everything

- Network Control
- Licensed spectrum Proprietary network
- Owned IP addresses Controlled protocols
- Filtered traffic Walled garden model
- Device Ownership
- Part of the network Selected by provider Heavily patented
- Proprietary software Heavily protected

Our Goal: Liberate Texting

- Break the phone companies' hold
- Make texting a Libre Service
- Break the walled garden: make it end-to-end
- Move it to the for-profit, non-proprietary quadrant
- Bring texting into the Internet mainstream

Breaking the Phone Companies' Hold

- Licensed spectrum Public spectrum: WiFi, MURS
- Closed networks Mobile end-to-end Internet: Mobile-IPv6, public IP address space allocation
- Patented protocols Patent-free protocols: EMSD, IMAP, SMTP
- Closed device paradigm GNU/Linux everywhere

- Walled garden applications End-to-end services

Texting vs. Libre Texting

- Today's Texting
- Closed device model
- Limited applications
- Bundled device + service
- Walled garden Internet
- Little privacy
- Advantage: Company
- Libre Texting
- Linux PDAs

- Free/Libre applications
- Device modularity: best-of-class choice
- End-to-end Internet
- Choice of privacy
- Advantage: User

The Many Dimensions of By* Libre Texting

- Libre Texting: a real-world alternative to texting
- Analysis of the texting medium
- Engineering execution: protocols, software, spectrum
- Libre Services model: philosophy, morality, legality
- By* Libre Texting execution

- By* Libre Services Open Business Plan
- History
- Evaluation, participation, collaboration. Join us!

Execution Strategy

- Non-proprietary: All patent-free and all Copyleft
- For-profit: Fully commercial and fully business oriented
- Collaborative development
- Competitive delivery

Libre Texting: Parts List

- Network
 - Public spectrum (unlicensed)
 - Existing Mobile and wireless networks

- Device

- ● Hardware: Linux PDAs (N-810, Mobile Internet Device)

- ● Software: Free/Libre -Linux (Maemo, Ubuntu MID)

- Server and Service

- ● Free/Libre server software

- ● Competitive Libre Texting services

- Protocols

- ● Efficient push-enabled patent-free protocols

Network Connectivity:

WiFi++

- Where there is no WiFi network connectivity,
- use WiFi as a bridge to other network connectivity.

- (e.g.) Public MURS: 150 MHz, nationwide
- • Narrowband & slow
- • Entirely adequate for texting
- • Libre Texting with {WiFi++}
<http://www.neda.com/PLPC/100027>

Public IP Address

Internet

WiFi++ Network Overview

Device: Linux PDA

E.g. Nokia 810

Access Point

Mobile Companion

WiFi Only

WiFi++

Base Station

Device: Linux PDA

E.g. Nokia 810

Libre Texting with WiFi++ and Existing Mobile Networks

- Early Off the shelf example: MiFi
 -
- WiMAX-WiFi++
 - ClearWire Service
 - Linux router laptop with Atheros WiFi Access Point
- MURS-WiFi++
 - Libre MURS Network
 - Linux router laptop with Atheros WiFi Access Point

Libre Texting Device Hardware: Supported Linux PDAs (2009)

- Nokia 810 (primary)

- Ziplt, etc.

Libre Texting Device Software

- Sophisticated access point detection
- Push delivery (openvpn + neda-emsd-ua.deb)
- Message alert: Texting style
- Mail User Agent (Gnus Emacs, Claws Mail, etc.)
 - Enhanced by texting-mode user interface
- Mail synchronization (offlineimap.deb)

Libre Texting Server Software

- qmail for SMTP, Submit, etc.
- Courier IMAP
- qmail-EMSD

- open-vpn server
- Web mail (SquirrelMail)
- etc.
- <http://www.neda.com/PLPC/110504>

Send / Receive Steps

- Mobility
 - Device: Detect and Select an Access Point
 - Device: Establish end-to-end IP connectivity (NAT)
 - Device: Initiate a VPN tunnel Use Permanent Address
- Delivery Push Mail To Device
 - Server: Recognize Device reachability Send EMSD-Deliver
 - Device: Receive with EMSD-UA-Deliver Alert MUA

- Submission From Device
 - Device: Use EMSD to submit message
 - Server: Inject the message into Internet MTS

Efficient Push-Mode

Texting Protocols

- SMTP/IMAP/POP/QMTP are non-starters for texting: connection-oriented, verbose and poll-mode. See efficiency comparison, later.
- EMSD: designed for texting, and the only efficient open protocol
- Component oriented
- Texting/email continuum

The Key Requirement: Efficiency

- Minimize number of bytes transferred

- Minimize number of transmissions
 - (fewer transmissions for lower energy consumption & longer battery life)
- Minimize user-experience response time
- Minimize code size
- Support miniaturized devices

EMSD, SMTP, IMAP, POP

Delivery Comparison: Number of Packets

EMSD, SMTP, IMAP, POP

Delivery Comparison: Number of Bytes

SMTP and EMSD:

Efficiency Comparison

EMSD Internet RFCs

- RFC-2188
- Efficient Short Remote Operation (ESRO) Protocol Specification

- ● Maintenance Organization: <http://www.esro.org>
- ● Software: <http://www.bysource.org>
- RFC-2524
- EMSDP (Efficient Mail Submission & Delivery Protocol)
- ● Maintenance Organization: <http://www.emsd.org>
- ● Software: <http://www.bybinary.org>

The Many Dimensions of By* Libre Texting

- Libre Texting: a real-world alternative to texting
- Analysis of the texting medium
- Engineering execution: protocols, software, spectrum
- Libre Services model: philosophy, morality, legality

- By* Libre Texting Service
- By* Libre Services Open Business Plan
- History
- Evaluation, participation, collaboration. Join us!

In English Free is ambiguous:

We need the word Libre

- Free can mean Libre:
free as in freedom of action
- Free can mean Gratis:
free as in zero monetary cost

Nature at work:

Non-material constructs flourish when free from ownership

When we say free we will always mean Libre:

freedom of action

Libre Services

- ● A non-proprietary model
- ● for
- ● delivery of Internet services

Proprietary vs. Non-Proprietary;

Software vs. Services

From Software Wars to Service Wars

Extension of Free Software into Libre Services

Transformation of Free Software into Libre Services

Libre Services: Definitional Criteria

- 1. The service must consist entirely of open-source & free software components
- 2. The service must be based entirely on patent-free protocols
- 3. The integration software must consist entirely of free software
-

- Hence the entire service is reproducible and modifiable based on access to source code

Non-Profit and For Profit:

Roles and Responsibilities

Benefits to Society

- Engineered for the user, not for business
- Civil liberties: services operated by the user, for the user
- Privacy and security
- Service stability and continuity
- Complex integration of user environments with services

The Many Dimensions of

By* Libre Texting

- Libre Texting: a real-world alternative to texting
- Analysis of the texting medium

- Engineering execution: protocols, software, spectrum
- Libre Services model: philosophy, morality, legality
- By* Libre Texting execution
- By* Libre Services Open Business Plan
- History
- Evaluation, participation, collaboration. Join us!
- By* Libre Texting
-
- ● Libre Services + By* Family = By* Services
- ● Libre Texting + By* Services = By* Libre Texting
- ●

- ● By* Libre Texting:
- ● the strategic spearhead for By* Libre Services

By* Libre Texting:

Part of a Bigger Picture

- ● Texting must be fully integrated into the user's
- ● computing and communications environment
- ●
- ● By* Libre Services

By* Services Overview

By* Features and Capabilities

- A named entity domain, owned by the entity
- ● A public website: My Internet
- ● An expanded website for friends: My Extranet

- ● A private portal: My Intranet
- By* Libre Self-Publication Facility
- By* Libre Texting
- Email, e-fax, etc.
- Blog, photo gallery, GeneWeb, etc.

By* Libre Services:

Software Components

- Debian GNU/Linux
- Base: djbdns, daemontools, ucspi, multilog, etc.
- Mail: qmail, courier, spamassassin, ezmlm, etc.
- Web: apache, zope, plone, etc.
- Misc: postgres, mysql, Interchange, etc.

- Glue: Libre Services Integration Platform (LSIP)

Service, Desktop, Laptop, PDA

Continuum

- Free/Libre everywhere
- Consistent OS: Linux everywhere
- Consistent GUI: Gnome everywhere
- Consistent Applications: Emacs etc., everywhere
- Deep, broad and consistent integration through Free Software and Libre Services

The Libre Texting/Email Continuum

- Not two different things
- Synchronized
- A quick interface for texting

- A rich interface for email
- The Unix way: components working together

The Many Dimensions of By* Libre Texting

- Libre Texting: a real-world alternative to texting
- Analysis of the texting medium
- Engineering execution: protocols, software, spectrum
- Libre Services model: philosophy, morality, legality
- By* Libre Texting execution
- By* Libre Services Open Business Plan
- History
- Evaluation, participation, collaboration. Join us!

The Neda Open Business Plan

- <http://www.neda.com/StrategicVision/BusinessPlan>
- Open Business Plan: available to all
- Broad audience: engineers, academics, investors
- Jujitsu on patents and copyright
- Engineers start here:
- <http://www.neda.com/StrategicVision/Participating/Engineering>
- Investors start here:
- <http://www.neda.com/StrategicVision/Participating/Investment/StartHere>

For Profit and Non-Proprietary:
the Right Paradigm for Non-Material Constructs
From Free Software to Libre Services
with a Clear Revenue Model

Transformation of
software into services

Proprietary software

Free software

Execution and Revenues:

Clear and Straightforward

- Execution
- Device: Linux PDAs, in place
- Service: By*, in place
- Mobile network: in place
- Revenues

- Individual:
subscription
- ● Software: Libre/Free, in place
- ● Public spectrum: in place
- ● Plan: Well developed, in place
- ● Vertical
integration
- ● Products:
CPE+service
- ● Corporate:
software as service

The Many Dimensions of By* Libre Texting

- Libre Texting: a real-world alternative to texting

- Analysis of the texting medium
- Engineering execution: protocols, software, spectrum
- Libre Services model: philosophy, morality, legality
- By* Libre Texting execution
- By* Libre Services Open Business Plan
- History
- Evaluation, participation, collaboration. Join us!

History

- We've been at this a very long time:
- CDPD and LSM (1994)
- pACT (1996)

- RFC-2188 (1998), and RFC-2524 (1999)
- The WAP Trap (2000)
- Operation WhiteBerry (2001)
- The LEAP Manifesto (2001)
- Libre Services Strategic Vision (2007)
- By* Libre Texting (2009)

AT&T pACT Revisited 12 Years Later

- Spectrum: 2 *50/50 kHz paired \$160 million
- Devices: PCSI, etc. \$20 million
- Message Center, Net, Air Link \$60 million
- Development abandoned in 1997. Total cost: \$240 million.

AT&T

pACT

- Spectrum: WiFi & MURS (public) \$0
- Devices: Nokia 810, Ziptl \$0
- gmail, mobile-ip, emsd (free software) \$0
- All you need to do is integrate it \$4 million
- Total cost: \$4 million

Libre

Texting

Evolution of Operation WhiteBerry
into Libre Texting

- Operation WhiteBerry
- <http://www.freeprotocols.org/PLPC/100006>
- Had several external dependencies:

- ● 1. Closed and limited network
- ● 2. Closed proprietary devices
- ● 3. Entry into walled gardens

Ten Years Later

- 1999
- Licensed spectrum
- Few closed networks
- Closed devices
- Little Libre software
- Walled garden
- 2009

- Public spectrum
- Many open networks
- Devices opening up
- A lot of Libre software
- Awareness of the harm

The Many Dimensions of By* Libre Texting

- Libre Texting: a real-world alternative to texting
- Analysis of the texting medium
- Engineering execution: protocols, software, spectrum
- Libre Services model: philosophy, morality, legality
- By* Libre Texting execution

- By* Libre Services Open Business Plan
- History
- Evaluation, participation, collaboration. Join us!

This is big and we are small,
but lots is in place

- EMSD protocols
- By* Libre Services
- Leadership of the Libre Services movement
- Fully committed to Libre: GNU/Linux everywhere
- Our own Data Center: LibreCenter.net
- Our own wireless network (MURS, WiFi)
- Well-developed Business Plan

For you to Evaluate:

All our Cards on the Table

- Open Business Plan 2009 By* Libre Services
- Libre Services Manifesto PLPC-100105
- By* full documentation PLPC-110004
- Unsolicited Proposal PLPC-110005
- By* Libre Texting PLPC-110012
- Operation Whiteberry PLPC-100006
- LEAP Manifesto PLPC-100012

Join Us!

Make it Happen in a Big Way

- Engineering community: Ideas, code, integration

- Business community: Buy into the Libre model, take the code, partner up, deploy the services
- Investment community: Financing
- Academic community: Ideas, code, integration, analysis, discussion
- Funding NGOs: Grants
- Government: Grants
- Society: Usage, testing, dialogue, awareness
- Media: Articles, analysis, discussion

Current Active Projects

- Sophisticated access point selection
- Qmail/EMSD integration

- Mail alert
- Linux PDA ports: Android, Ziplt
- EMSD and ESRO enhancements
- Texting GUI
- Mobile IP
- Public spectrum AirLink